

CE EN795/B:12, EN566:06, EN354:10, CEN/TS16415/B:13

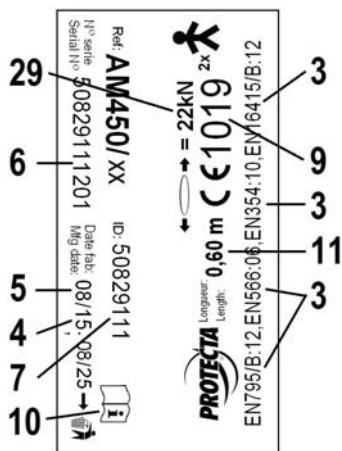

	0,085kg	Bouclerie Buckle Dispositivo di chiusura Hebilleria Beschlagteile 13	Sangle Webbing Fune Cincha Gurband 15	Fil Thread Filo di cucitura Hilo de coser Naht-garn 12
Longueur Length Lunghezza Longitud Länge 11	0.80 m	Matiere Material Materiale Material Material 18	Polyester Polyester Poliestere Poliester Polyester 20	Polyamide Polyamide Poliammide Poliamida Polyamid 19
Année de fabrication Manufacturing year Anno di fabbricazione Año de fabricación Baujahr 4	2016	EXAMEN CE DE TYPE CE TYPE EXAMEN ESAME CE DEL TIPO EFFETUATO EXAMEN CE DE TIPO EFETUADO POR CE-TYPENPRÜFUNG DURCH 8	N°1019 : VVUU a.s. Pikartska 1377/7 716 07 Ostrava - Radvanice Czech Republic	
BATCH / ID 7		SUMI QUALITE PRODUCTION QUALITY CONTROL ORGANISMO VALUTAZIONE CONFORMITA ORGANISMO DE CONTROLA HERSTELLUNGSKONTROLLE 9	N°1019 : VVUU a.s. Pikartska 1377/7 716 07 Ostrava - Radvanice Czech Republic	

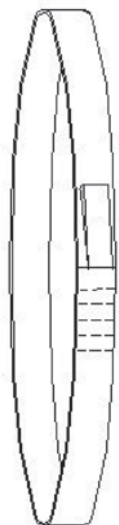
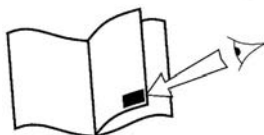

Veuillez lire la notice générale / Please read the general instructions / Leggere le istruzioni generali / Sivase leer el manual general / Bitte allgemeingültige Anweisung lesen

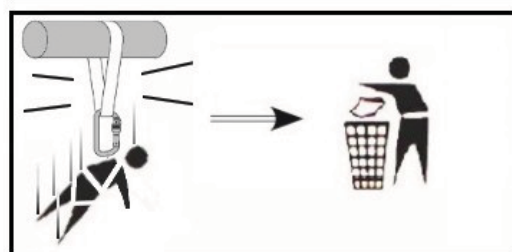
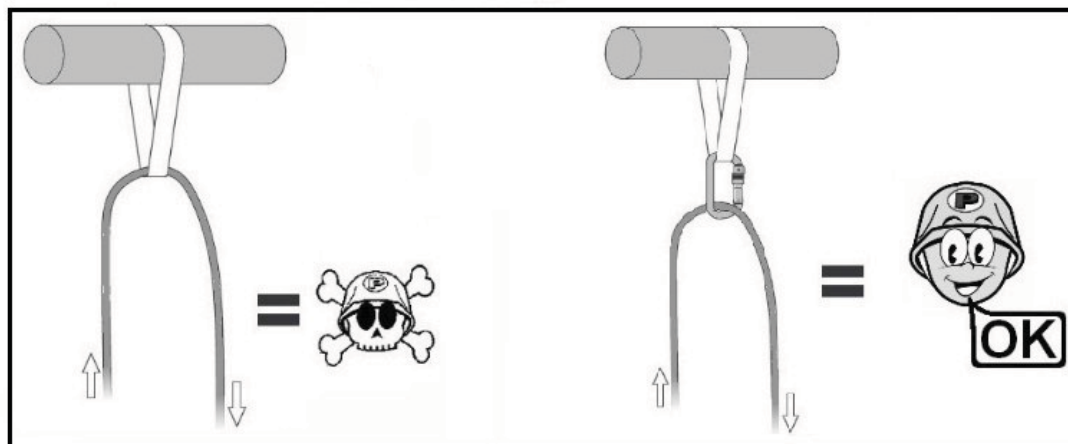
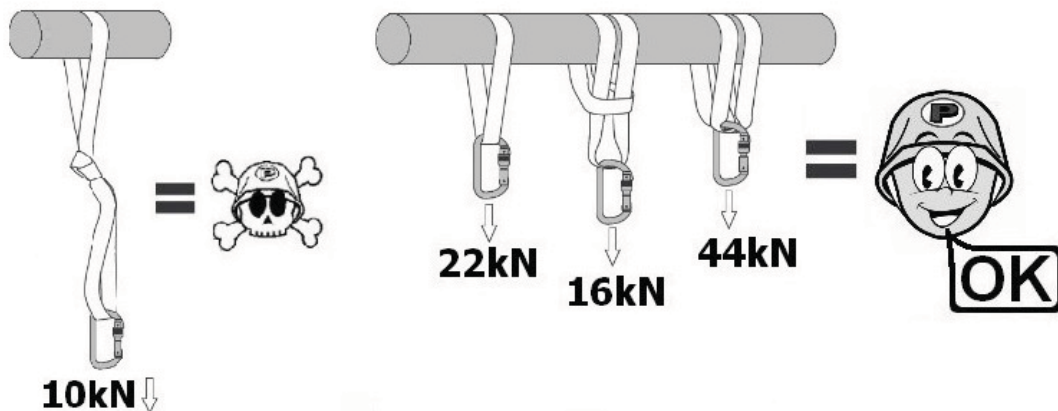

- FR:**  
3 = Norme européenne  
4 = Année de fabrication  
5 = Mois de fabrication  
6 = Numéro de série  
7 = Numéro de lot  
8 = Examen CE de type effectué par  
9 = N°organisme controlant cet EPI  
10 = Attention: lire la notice  
11 = Longueur  
29 = Résistance à la rupture
- EN:**  
3 = European Standard  
4 = Year of manufacture  
5 = Month of manufacture  
6 = Serial number  
7 = Batch number  
8 = EC test performed by  
9 = Number of quality control Body  
10 = Note: read the notice  
11 = Length  
29 = Breaking strength
- IT:**  
3 = Norma europea  
4 = Anno di fabbricazione  
5 = Mese di fabbricazione  
6 = Numero di serie  
7 = Numero di lotto  
8 = Esame CE del tipo effettuato da  
9 = Numero dell'organismo di valutazione della conformità di questo EPI  
10 = Attenzione: leggere le istruzioni  
11 = Lunghezza  
29 = Resistenza alla rottura
- ES:**  
3 = Normativa europea  
4 = año de fabricación  
5 = Mes de fabricación  
6 = Número de serie  
7 = Número de lote  
8 = Examen CE de tipo efectuado por  
9 = Número del organismo que controla la fabricación de este EPI  
10 = Cuidado: leer el manual  
11 = Longitud  
29 = Resistencia a la rotura
- DE:**  
3 = Europäische Norm  
4 = Baujahr  
5 = Herstellungsmonat  
6 = Serien-Nummer  
7 = Cargen-Nummer  
8 = CE-Typenprüfung durch  
9 = Nummer der mit der Herstellungskontrolle dieser  
10 = Achtung: Anweisung lesen  
11 = Länge  
29 = Bruchfestigkeit



**СПЕЦИАЛЬНАЯ  
ИНСТРУКЦИЯ**

**АНКЕРНАЯ  
ПЕТЛЯ**

**AM450/80**

**EAC** ГОСТ Р ЕН 795-2009 В  
ТР ТС 019/2011

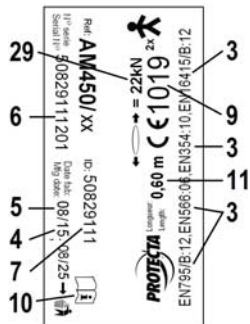

Длина 11  
**0,80 m**

Застежка	Перевязь	Нить ткани
	Полиэстер	Полиамид

	+ 57°C - 35°C		0,085kg
--	------------------	--	---------

Год производства 4  
**2016**

СЕРТИФИКАТ СООТВЕТСТВИЯ CE 8  
N°1019 :  
VVUU a.s.  
Pikartska 1377/7  
716 07 Ostrava - Radvanice  
Czech Republic

BATCH / ID 7

НОМЕР ОРГАНИЗАЦИЯ 9  
N°1019 :  
VVUU a.s.  
Pikartska 1377/7  
716 07 Ostrava - Radvanice  
Czech Republic



**Пожалуйста общую инструкцию**

3 = Европейский стандарт; 4 = Год производства; 5 = Месяц производства; 6 = Серийный номер; 7 = Номер лота; 8 = Сертификат соответствия CE;  
9 = Номер организация, контролирующей производство данного изделия; 10 = Внимание: читайте инструкцию; 11 = Длина; 29 = Прочность на разрыв

